

LED NUMERIC DISPLAY, 1 DIGIT
BL-S39X-14
■ Features:

- 10.0mm (0.39") Single digit numeric display series
- Low current operation.
- Excellent character appearance.
- Easy mounting on P.C. Boards or sockets.
- I.C. Compatible.
- ROHS Compliance.

Super Bright
Electrical-optical characteristics: (Ta=25°C) (Test Condition: IF=20mA)

Part No		Chip			VF Unit:V		Iv TYP.(mcd)
Common Cathode	Common Anode	Emitted Color	Material	λ_p (nm)	Typ	Max	
BL-S39A-14S-XX	BL-S39B-14S-XX	Hi Red	GaAlAs/GaAs,SH	660	1.85	2.20	8
BL-S39A-14D-XX	BL-S39B-14D-XX	Super Red	GaAlAs/GaAs,DH	660	1.85	2.20	15
BL-S39A-14UR-XX	BL-S39B-14UR-XX	Ultra Red	GaAlAs/GaAs,DDH	660	1.85	2.20	17
BL-S39A-14E-XX	BL-S39B-14E-XX	Orange	GaAsP/GaP	635	2.10	2.50	10
BL-S39A-14Y-XX	BL-S39B-14Y-XX	Yellow	GaAsP/GaP	585	2.10	2.50	10
BL-S39A-14G-XX	BL-S39B-14G-XX	Green	GaP/GaP	570	2.20	2.50	10

Ultra Bright
Electrical-optical characteristics: (Ta=25°C) (Test Condition: IF=20mA)

Part No		Chip			VF Unit:V		Iv TYP.(mcd)
Common Cathode	Common Anode	Emitted Color	Material	λ_p (nm)	Typ	Max	
BL-S39A-14UHR-XX	BL-S39B-14UHR-XX	Ultra Red	AlGaInP	645	2.10	2.50	17
BL-S39A-14UE-XX	BL-S39B-14UE-XX	Ultra Orange	AlGaInP	630	2.10	2.50	13
BL-S39A-14YO-XX	BL-S39B-14YO-XX	Ultra Amber	AlGaInP	619	2.10	2.50	13
BL-S39A-14UY-XX	BL-S39B-14UY-XX	Ultra Yellow	AlGaInP	590	2.10	2.50	13
BL-S39A-14UG-XX	BL-S39B-14UG-XX	Ultra Green	AlGaInP	574	2.20	2.50	15
BL-S39A-14PG-XX	BL-S39B-14PG-XX	Ultra Pure Green	InGaN	525	3.80	4.50	20
BL-S39A-14B-XX	BL-S39B-14B-XX	Ultra Blue	InGaN	470	2.70	4.20	26
BL-S39A-14W-XX	BL-S39B-14W-XX	Ultra White	InGaN	/	2.70	4.20	32

■ -XX: Surface / Lens color:

Number	0	1	2	3	4	5
Ref Surface Color	White	Black	Gray	Red	Green	
Epoxy Color	Water clear	White diffused	Red Diffused	Green Diffused	Yellow Diffused	

LED NUMERIC DISPLAY, 1 DIGIT
BL-S39X-14
Absolute maximum ratings (Ta=25°C)

Parameter	S	D	UR	E	Y	G	Unit
Forward Current I_F	25	25	25	25	25	30	mA
Power Dissipation P_d	60	60	60	60	60	65	mW
Reverse Voltage V_R	5	5	5	5	5	5	V
Peak Forward Current I_{PF} (Duty 1/10 @1KHZ)	150	150	150	150	150	150	mA
Operation Temperature T_{OPR}	-40 to +80						°C
Storage Temperature T_{STG}	-40 to +85						°C
Lead Soldering Temperature T_{SOL}	Max.260±5°C for 3 sec Max. (1.6mm from the base of the epoxy bulb)						°C

■ Absolute maximum ratings (Ta=25°C)

Parameter	UHR	UE	YO	UY	UG	PG	UB	UW	Unit
Forward Current I_F	30	30	30	30	30	30	30	30	mA
Power Dissipation P_d	75	65	65	65	75	110	120	120	mW
Reverse Voltage V_R	5	5	5	5	5	5	5	5	V
Peak Forward Current I_{PF} (Duty 1/10 @1KHZ)	150	150	150	150	150	150	100	100	mA
Operation Temperature T_{OPR}	-40 to +80								°C
Storage Temperature T_{STG}	-40 to +85								°C
Lead Soldering Temperature T_{SOL}	Max.260±5°C for 3 sec Max. (1.6mm from the base of the epoxy bulb)								°C

LED NUMERIC DISPLAY, 1 DIGIT

BL-S39X-14

■ Package configuration & Internal circuit diagram

BL-S39X-14 Series

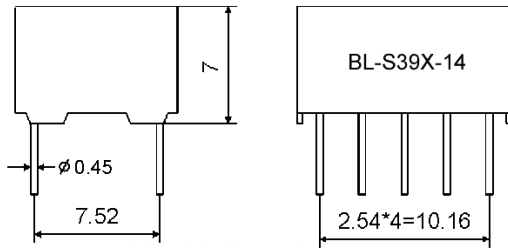
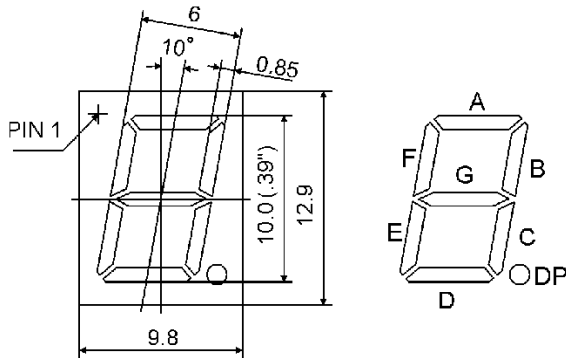

BL-S39A-14

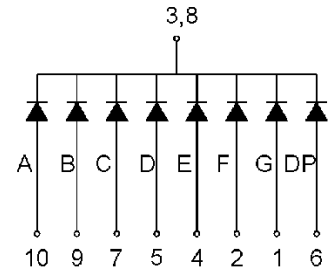

BL-S39B-14

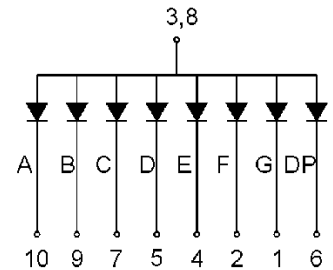

Notes:

1. All dimensions are in millimeters (inches)
2. Tolerance is $\pm 0.25(0.01)$ unless otherwise noted.
3. Specifications are subject to change without notice.

LED NUMERIC DISPLAY, 1 DIGIT

BL-S39X-14

Typical electrical-optical characteristics curves:



- | | |
|---|--------------------------------------|
| (1) - GaAsP/GaAs 655nm/Red | (9) - GaAlAs 880nm |
| (2) - GaP 570nm/Yellow Green | (10) - GaAs/GaAs & GaAlAs/GaAs 940nm |
| (3) - GaAsP/GaP 585nm/Yellow | (A) - GaN/SiC 430nm/Blue |
| (4) - GaAsP/GaP 635nm/Orange & Hi-Eff Red | (B) - InGaN/SiC 470nm/Blue |
| (5) - GaP 700nm/Bright Red | (C) - InGaN/SiC 505nm/Ultra Green |
| (6) - GaAlAs/GaAs 660nm/Super Red | (D) - InGaN/SiC 525nm/Ultra Green |
| (8) - GaAsP/GaP 610nm/Super Red | |

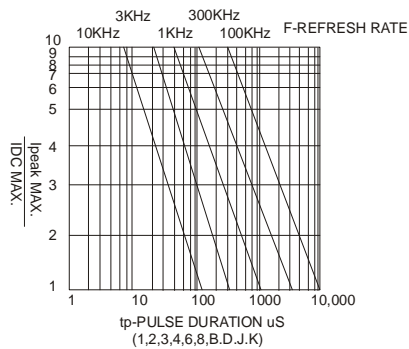
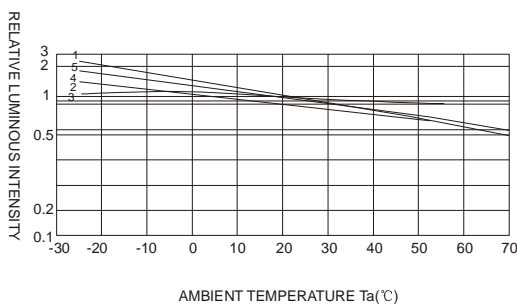

NOTE:25°C free air temperature unless otherwise specified